

Specification	5kV-70A 2 Pins with ICF70 Flange
Model No.	PF-CM5-5kV-70A-I70-2
Contact	osaka-sales@kawaso-texcel.co.jp Koeln-sales@kawaso-texcel.de (in Europe)
Kawaso Texcel CO., Ltd.	

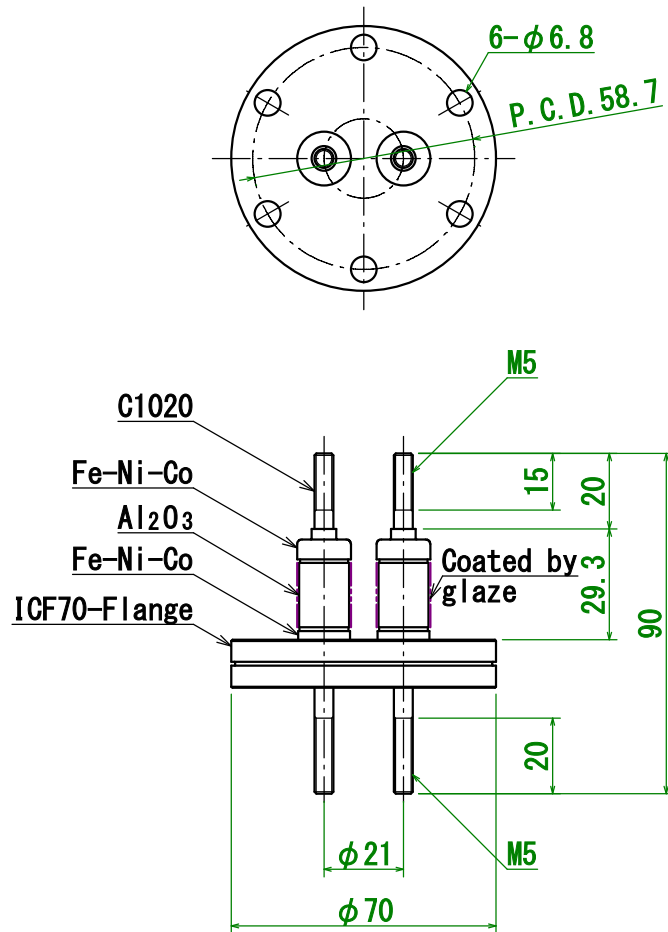

Model No. : PF-CM5-5kV-70A-I70-2

Caution : If you use crimp terminal and SUS nuts for the connection to the electrode of feedthrough, SUS nuts may become HIGH Temperature

Dimensions are in Millimeter.