

Specification	12kV-100A 1 Pin with ICF34 Flange
Model No.	PF-CM6-12kV-100A-I34-1
Contact	osaka-sales@kawasotexcel.co.jp Koeln-sales@kawasotexcel.de (in Europe)
Kawasotexcel CO., Ltd.	

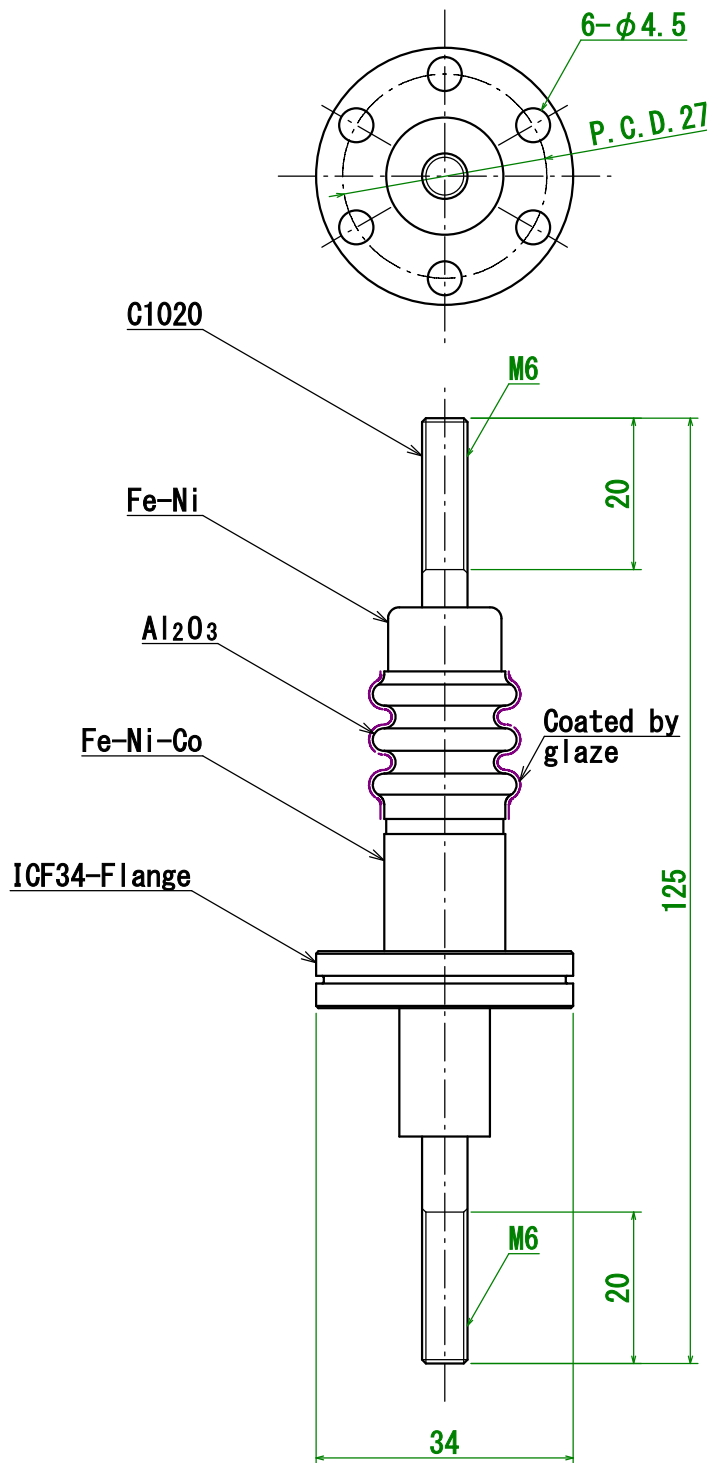

Model No. : PF-CM6-12kV-100A-I34-1

Caution : If you use crimp terminal and SUS nuts for the connection to the electrode of feedthrough, SUS nuts may become HIGH Temperature

Dimensions are in Millimeter.