

Specification	3kV-100A ICF70-Flange 2P
Catalog number	PF-CM6-3kV-100A-L-I70-2
Contact Us	osaka-sales@kawaso-texcel.co.jp Koeln-sales@kawaso-texcel.de (in Europe)
Kawaso Texcel CO., Ltd.	

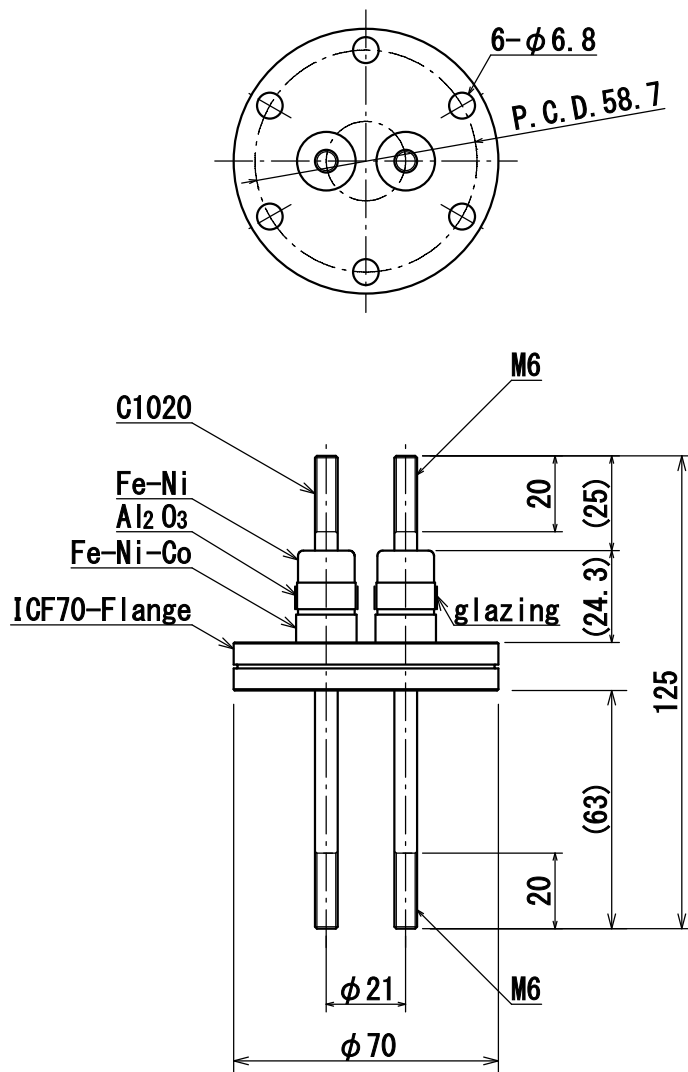

Catalog number : PF-CM6-3kV-100A-L-I70-2

※ When you will fix the crimp terminal to electrode by SUS nut, SUS nut may have high temperature based on the fixing method.