

Specification	5kV-8A 1 Pin with ICF34 Flange
Model No.	PF-SM5-5kV-8A-I34-1
Contact	osaka-sales@kawasotexcel.co.jp Koeln-sales@kawasotexcel.de (in Europe)
Kawasotexcel CO., Ltd.	

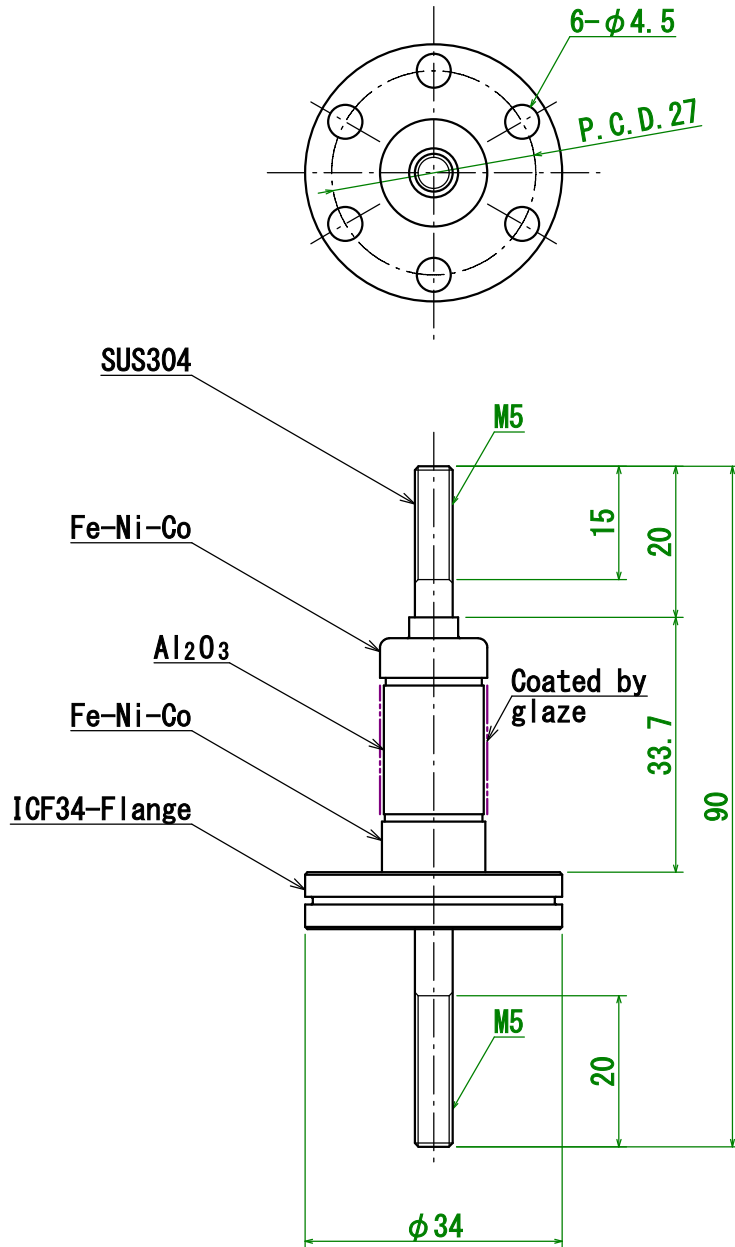

Model No. : PF-SM5-5kV-8A-I34-1

Dimensions are in Millimeter.