

Product Name	Aluminium Liquid Cold Plate
Model number	HS-A150-170-P86-127-M6
Inquiry phone number	Osaka CMB Sales office +81-6-6532-1301
	Kawaso Texcel Corporation

ver.1.0.1

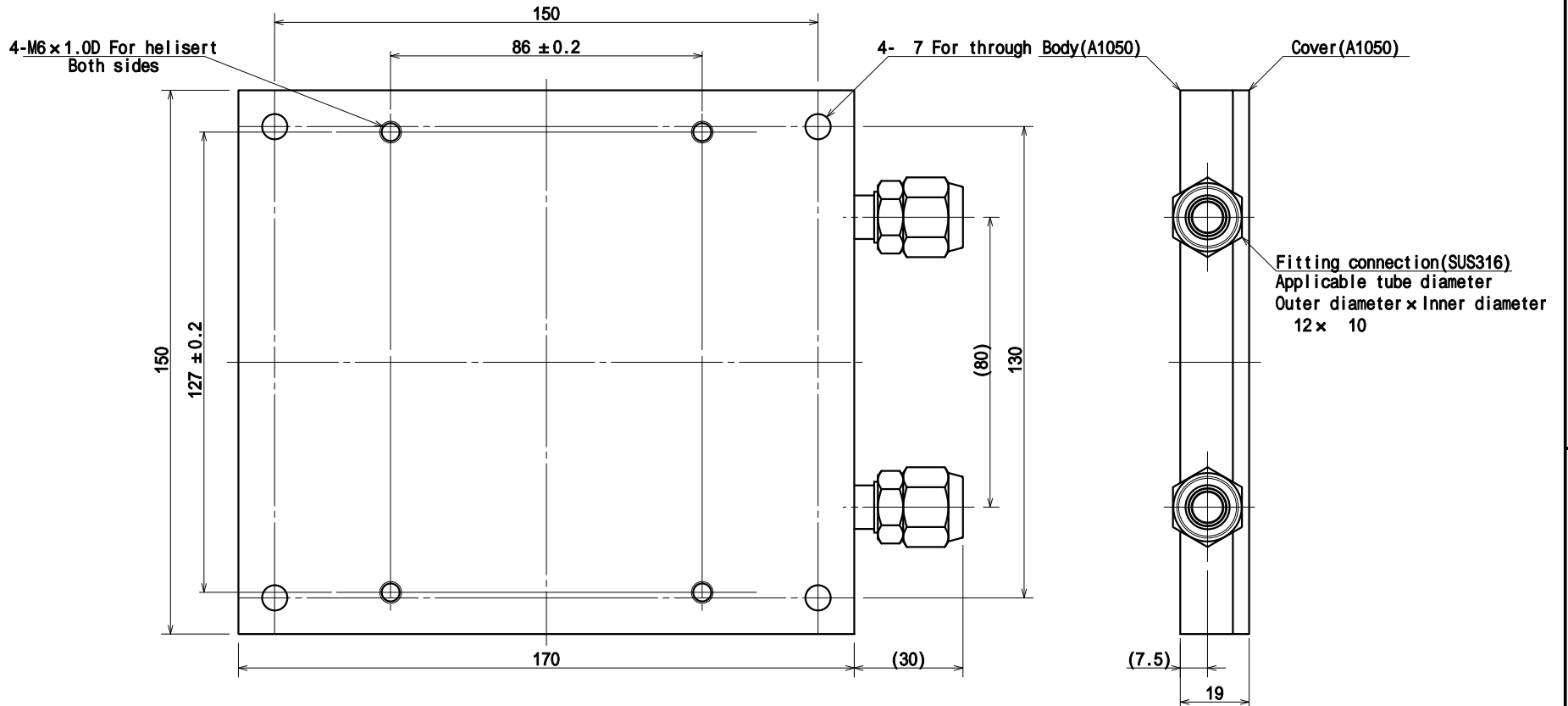

Weight : about 1.2kg

Specifications

There are processing marks on the cooling surface.
 In order to ensure heat sink performance, surface flatness and parallelism of the product is set to 0.02 mm or less.
 Commercial bolts (JIS B 0209-1 fitting classification: middle) pass through the threaded section.
 There is a step (about 0.5 to 1.0 mm) at the joint between the body and the cover.
 However, the cover does not go outward from the body.
 Performed matt Ni plating (2 μm) on the whole as base plating.
 When machining inside the tapped holes, inside the holes may be non-plated.

Handling Precautions

Pure water or antifreeze containing corrosion inhibitor is recommended for coolant.
 Even when pure water is used, it is recommended to install an ion exchange unit to prevent ion concentration increase in circulating water.
 Because city water and industrial water may corrode aluminium, please refrain from using.
 When attaching the tube to the fitting connection, please fix it with a tool so that no force is applied to the joint between the fitting connection and aluminium.
 Please note that dimensions and specifications may be changed without prior notice.