

Specification	5kV-8A 2 Pins with ICF70 Flange
Model No.	PF-SM5-5kV-8A-I70-2
Contact	osaka-sales@kawaso-texcel.co.jp Koeln-sales@kawaso-texcel.de (in Europe)
Kawaso Texcel CO., Ltd.	

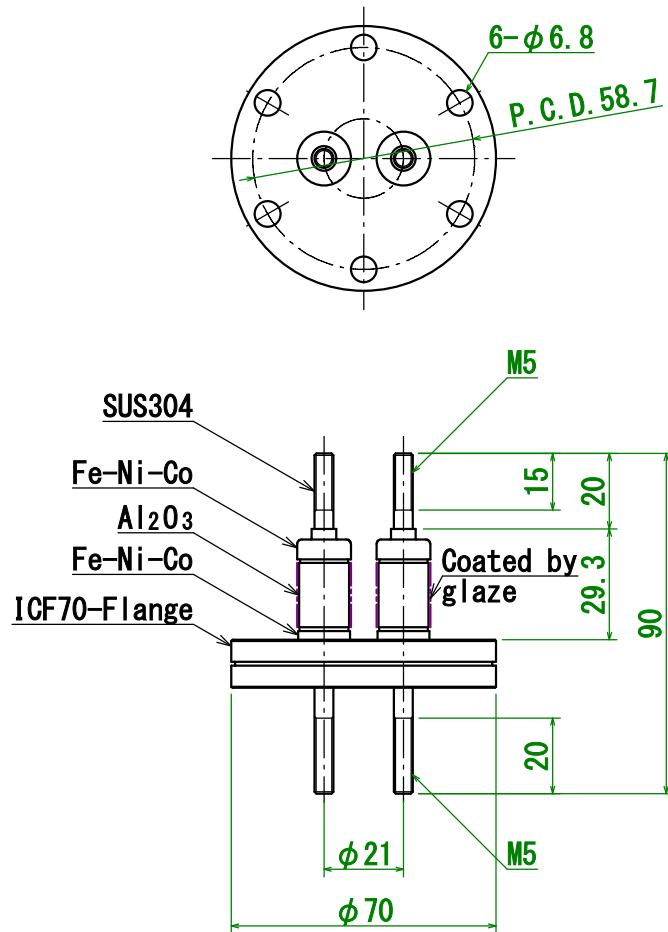

Model No. : PF-SM5-5kV-8A-I70-2

Dimensions are in Millimeter.